

# GRANIT™ ULTRA ULTRA-RUGGED INDUSTRIAL SCANNER

Configuration Guide



**TOOL BALANCER**



**CHARGE BASE**



**VEHICLE HOLDER**



**2100i  
TETHERED**



**2105i  
BLUETOOTH**

THE  
FUTURE  
IS  
WHAT  
WE  
MAKE IT

**Honeywell**

# TABLE OF CONTENTS

- 1 TABLE OF CONTENTS
- 2 GRANIT<sup>™</sup> ULTRA FEATURE OVERVIEW
  - GRANIT ULTRA 2100I TETHERED SCANNER
  - GRANIT ULTRA 2100I TETHERED SCANNER CONFIGURATIONS
  - GRANIT ULTRA 2105I BLUETOOTH SCANNER
  - GRANIT ULTRA 2105I BLUETOOTH SCANNER TO COMPUTER
  - GRANIT ULTRA 2105I BLUETOOTH SCANNER - CHARGE ONLY BASE
  - GRANIT ULTRA 2105I BLUETOOTH SCANNER CONFIGURATIONS
- 7 HONEYWELL EDGE SERVICES
  - 2100I/ 2105I - REPAIR SERVICES
  - GOLD REPAIR SERVICES - 3 YEAR
  - PLATINUM REPAIR SERVICES - 3 YEAR
  - GOLD REPAIR SERVICES - 5 YEAR
  - PLATINUM REPAIR SERVICES - 5 YEAR
  - 2100I/ 2105I - REPAIR SERVICES COVERAGE
- 10 MISCELLANEOUS
  - GRANIT ULTRA CABLE OPTIONS - USB
  - GRANIT ULTRA CABLE OPTIONS - USB
  - GRANIT ULTRA CABLE OPTIONS - SERIAL
  - GRANIT ULTRA CABLE OPTIONS - SERIAL / KEYBOARD WEDGE
  - OPTIONAL PARTS
- 18 APPENDIX
  - COMPARE GRANIT XP 1990I/ 1991I TO GRANIT ULTRA 2100I/ 2105I



# GRANIT™ ULTRA FEATURE OVERVIEW

## Granit Ultra 2100i Tethered Scanner

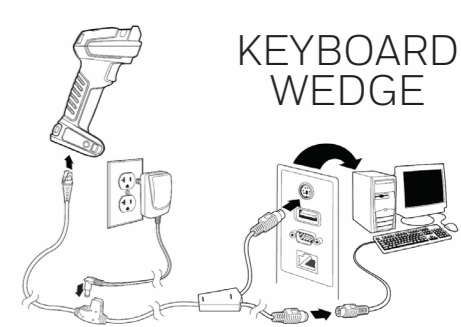
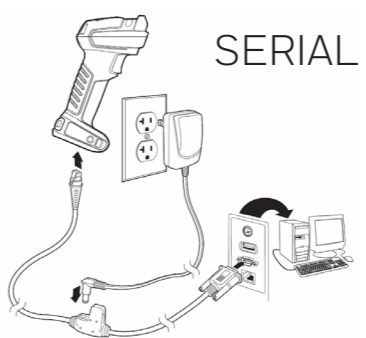
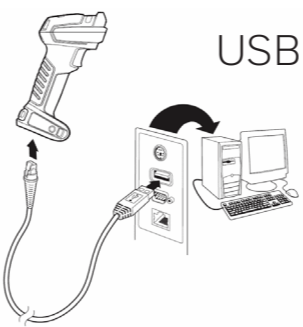

2100i Side View



2100i Cable Detail View



2100i Angle View

# GRANIT™ ULTRA FEATURE OVERVIEW

## Granit Ultra 2100i Tethered Scanner Configurations

	 <b>STANDARD RANGE (SR) LED AIMER</b> 	 <b>EXPANDED RANGE (XR) LASER AIMER (CLASS 2)</b> 
<b>Scanner Only</b>	<b>2100iSR - Tethered</b>	<b>2100iXR - Tethered</b>
	<b>2100iSR-3x</b>	<b>2100iXR-3x</b>
		
	Granit Ultra Scanner-Only: Tethered, Rugged, 1D/2D, Standard Range, Vibrator, Red Scanner. Compatible with RS232/USB/KBW cables (not included)	Granit Ultra Scanner-Only: Tethered, Rugged, 1D/2D, FlexRange, Vibrator, Red Scanner. Compatible with RS232/USB/KBW cables (not included)
<b>Scanner + USB Cable</b>	<b>2100iSR - Tethered</b>	<b>2100iXR - Tethered</b>
<b>CBL-500-300-S00 CBL-500-300-S00-03</b>	<b>2100iSR-3USBx</b>	<b>2100iXR-3USBx</b>
		
USB Type A 3m Straight	Granit Ultra USB Kit: Tethered, Rugged, 1D/2D, Standard Range, Vibrator, Red Scanner (2100iSR-3USB), USB Cable (CBL-500-300-S00)	Granit Ultra USB Kit: Tethered, Rugged, 1D/2D, FlexRange, Vibrator, Red Scanner (2100iXR-3USB), USB Cable (CBL-500-300-S00)
<b>Scanner + Serial Cable</b>	<b>2100iSR - Tethered</b>	<b>2100iXR - Tethered</b>
<b>CBL-020-300-C00 CBL-020-300-C00-02</b>	<b>2100iSR-3SERx</b>	<b>2100iXR-3SERx</b>
		
Serial RS232, 5V, DB9 Female, Coiled, 3m cable	Granit Ultra RS232 Kit: Tethered, Rugged, 1D/2D, FlexRange, Vibrator, Red Scanner (2100iSR-3SER), RS232 Cable (CBL-020-300-C00)	Granit Ultra RS232 Kit: Tethered, Rugged, 1D/2D, FlexRange, Vibrator, Red Scanner (2100iXR-3SER), RS232 Cable (CBL-020-300-C00)

Note: Not all scanner combinations are available in every region. Check your local Price Book to see which part numbers are available for sale.

x = Regional SKU

A: APAC  
I: India

C: China  
J: Japan

E: European Union (EU)  
N: North America

G: TAA  
R: Rest Of World (ROW)

# GRANIT™ ULTRA FEATURE OVERVIEW

## Granit Ultra 2105i Bluetooth Scanner

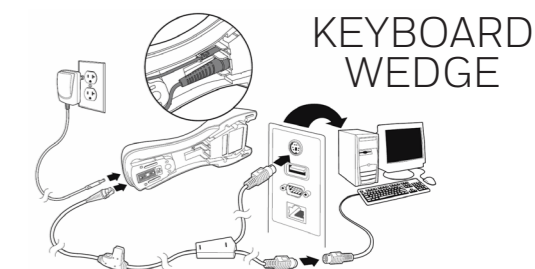
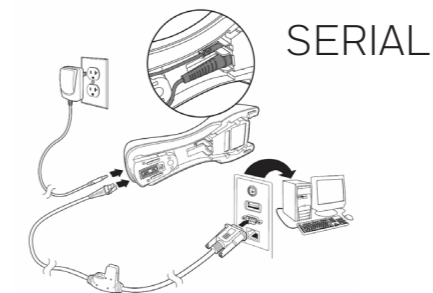
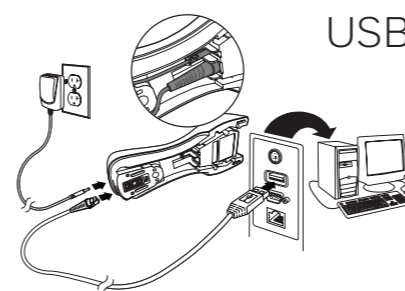

2105i Communications Charge Base (CCB) View



2105i Battery Door Detail View



2105i Angle View



2105i Bluetooth Status and Battery Icon View

Battery



BAT-SCN11 Smart Battery

MANUFACTURER INFORMATION	CHARGING	TEMPERATURE	CONDITION
<b>SERIAL NUMBER</b> 243520638	<b>BATTERY TIME TO FULL</b> Not Available	<b>MINIMUM TEMPERATURE</b> 19 °C	<b>HEALTH</b> 99 %
<b>DATE OF MANUFACTURE</b> 29/08/2024	<b>BATTERY TIME TO EMPTY</b> 1503 min	<b>MAXIMUM TEMPERATURE</b> 30 °C	<b>CHARGE CYCLES</b> 0
	<b>CHARGER STATE</b> Discharging	<b>CURRENT TEMPERATURE</b> 24 °C	<b>VOLTAGE</b> 4138 V
	<b>BATTERY LEVEL</b> 99 %		

Menu Command BTRINF can be used to retrieve the Smart Battery information.

# GRANIT™ ULTRA FEATURE OVERVIEW

## Granit Ultra 2105i Bluetooth Scanner to Computer

Use a Bluetooth Access Point to connect multiple scanners to a computer.

Allow up to 7 Bluetooth devices to connect simultaneously, and easy pairing via scanning the EZPairing LnkB barcode.



**PART NUMBER**

**DESCRIPTION**

1	AP-100BT-07N	Access point for Granit Ultra, XP scanners. Class 1 Bluetooth, 100m, up to 7 Granit scanners can be connected (cables sold separately).
---	--------------	---

## Granit Ultra 2105i Bluetooth Scanner – Charge Only Base

When pairing with tablets or smart phones, use CCB23 base with BASLNK0 to avoid unwanted bluetooth pairing, when using the AC Power Supply for charging, charging will complete faster compared to using the USB cable.



Note: Charge Only mode can be enabled by using BASLNK0

**PART NUMBER**

**DESCRIPTION**

1	CCB23-100BT-07N	Base: Charge and Communication. Class 1 Bluetooth. 100m (300'), up to 3 scanners can be connected. Compatible with RS232/USB/KBW cables (sold separately).
2	PS-05-3000-W-U	Power Supply: Includes US, UK, ANZ,EU plugs, 3.0A @ 5.2VDC, 100-255VAC @ 50-60Hz

# GRANIT™ ULTRA FEATURE OVERVIEW

## Granit Ultra 2105i Bluetooth Scanner Configurations

	 <b>STANDARD RANGE (SR) LED AIMER</b> 	 <b>EXPANDED RANGE (XR) LASER AIMER (CLASS 2)</b> 
<b>Scanner Only</b>	<b>2105iSR - Bluetooth</b>	<b>2105iXR - Bluetooth</b>
<b>BAT-SCN11</b> 	<b>2105iSR-3-CLx</b> 	<b>2105iXR-3-CLx</b> 
Battery	Granit Ultra Scanner-Only: Bluetooth, Rugged, 1D/2D, Standard Range, Vibrator, Contact Charging, Red Scanner, Battery (BAT-SCN11).	Granit Ultra Scanner-Only: Bluetooth, Rugged, 1D/2D, FlexRange, Vibrator, Contact Charging, Red Scanner, Battery (BAT-SCN11).
<b>Scanner + USB Cable</b>	<b>2105iSR - Bluetooth</b>	<b>2105iXR - Bluetooth</b>
<b>CBL-500-300-S00 CBL-500-300-S00-01</b> 	<b>2105iSR-3USB-CLHx</b> 	<b>2105iXR-3USB-CLHx</b> 
USB Type A 3m Straight	Granit Ultra USB Kit: Bluetooth, Rugged, 1D/2D, Standard Range, Vibrator, Contact Charging, Red Scanner (2105iSR-3USB-CL), Battery (BAT-SCN11), USB Cable (CBL-500-300-S00), Horizontal Base (CCB23-100BT-07N).	Granit Ultra USB Kit: Bluetooth, Rugged, 1D/2D, FlexRange, Vibrator, Contact Charging, Red Scanner (2105iXR-3USB-CL), Battery (BAT-SCN11), USB Cable (CBL-500-300-S00), Horizontal Base (CCB23-100BT-07N).
<b>Scanner + Serial Cable</b>	<b>2105iSR - Bluetooth</b>	<b>2105iXR - Bluetooth</b>
<b>CBL-020-300-C00 CBL-020-300-C00-01</b> 	<b>2105iSR-3SER-CLHx</b> 	<b>2105iXR-3SER-CLHx</b> 
Serial RS232, 5V, DB9 Female, Coiled, 3m cable	RS232 Kit: Wireless. Ultra rugged/industrial. 1D, PDF417, 2D, SR focus, with vib. Red scanner (199iXR-3), smart battery (BAT-SCN05), charge & comm. base (CCB22-100BT-03N), RS232 Cable, DB9, Female, coiled, 3m, 5V Signal (CBL-020-300-C00).	Granit Ultra RS232 Kit: Bluetooth, Rugged, 1D/2D, FlexRange, Vibrator, Contact Charging, Red Scanner (2105iXR-3SER-CL), Battery (BAT-SCN11), RS232 Cable (CBL-020-300-C00), Horizontal Base (CCB23-100BT-07N)

# HONEYWELL EDGE SERVICES

## 2100i/ 2105i - Repair Services

Honeywell Edge Services give you the confidence of having leading-class technologies combined with service and support plans that are designed to keep you operational for longer.

For a full description of maintenance services, including terms and conditions, please see <https://automation.honeywell.com/us/en/services/productivity-solutions/support-services/maintenance-services>

### Gold Repair Services - 3 Year

The Edge Services Gold Support contract allows flexibility for you to select the right coverage for your organization, including 5-Day Depot Repairs and:

#### Service Overview

- Repair or replacement (at Honeywell discretion) for damaged components, wear and tear, accidental damage
- Flexibility to add any Add-On Service

PART NUMBER	DESCRIPTION
SVC2100i-SG3N	2100i, Edge Service, GOLD Maintenance Contract, 5 Day Turnaround, <b>3 Year</b> , New Contract
SVC2105i-SG3N	2105i, Edge Service, GOLD Maintenance Contract, 5 Day Turnaround, <b>3 Year</b> , New Contract

#### Add-On Accessory Replacement Service

Provides replacement chargers, docks, charging cables, or scan handles should they be damaged or stop working.

<b>ADD</b> SVCACC-SCN3	AddOn, Edge Service, Accessory Service , Scanner, <b>3 Year</b> . Service covers power supplies, chargers and cables.
------------------------	---

#### Add-On Battery Replacement Service

Provides replacement batteries as needed after a minimum of 18 months post-purchase.

<b>ADD</b> SVCBATTERY-SCN3	AddOn, Edge Service, Battery Service, Scanner, <b>3 Year</b> , 1 Replacement Battery over life of the contract.
----------------------------	---

#### Add-On Device Replacement Service

Replacement devices should a device be damaged beyond repair.

<b>ADD</b> SVCREPLACE-SCN3	AddOn, Edge Service, Device Replacement, Scanner, <b>3 Year</b>
----------------------------	---

#### Add-On Spare Management Service

Manages every aspect of your spare pool.

<b>ADD</b> SVCSPAREMGMT-SCN3	AddOn, Edge Service, Advanced Exchange, Scanner, <b>3 Year</b> . Customer owned spare pool, Minimum Purchase required, contact your local Honeywell Service Representative for more information.
------------------------------	--

#### Add-On 2-Day Turnaround Depot Upgrade

Upgrade your Gold Maintenance Contract from 5-Day to 2-Day turnaround at the repair depot.

<b>ADD</b> SVC2DAYDEPOT-SCN3	AddOn, Edge Service, 2-Day Depot Upgrade, <b>3-Year</b> Agreement, Requires purchase of a <b>3 Year</b> Gold Maintenance Contract.
------------------------------	--

### Platinum Repair Services - 3 Year

The Edge Services Platinum Support contract offers 2-Day Depot Repairs or Spare Pool Management with 3 year contract that includes:

#### Service Overview

- Repair or replacement of damaged components
- SVCREPLACE-SCN3 - Replacement devices should a device be damaged beyond repair
- SVCACC-SCN3 - Accessory replacement service
- SVCBATTERY-SCN3 - Battery replacement service
- SVCSPAREMGMT-SCN3 - Spare pool management (optional, minimum quantity required)
- Telephone-based technical support

PART NUMBER	DESCRIPTION
SVC2100i-SP3N	2100i, Edge Service, PLATINUM Maintenance Contract, 1 Day Turnaround, <b>3 Year</b> , New Contract
SVC2105i-SP3N	2105i, Edge Service, PLATINUM Maintenance Contract, 1 Day Turnaround, <b>3 Year</b> , New Contract





# HONEYWELL EDGE SERVICES

## 2100i/ 2105i - Repair Services

Honeywell Edge Services give you the confidence of having leading-class technologies combined with service and support plans that are designed to keep you operational for longer.

For a full description of maintenance services, including terms and conditions, please see <https://automation.honeywell.com/us/en/services/productivity-solutions/support-services/maintenance-services>

### Gold Repair Services - 5 Year

The Edge Services Gold Support contract allows flexibility for you to select the right coverage for your organization, including 5-Day Depot Repairs and:

#### Service Overview

- Repair or replacement (at Honeywell discretion) for damaged components, wear and tear, accidental damage
- Flexibility to add any Add-On Service

PART NUMBER	DESCRIPTION
SVC2100i-SG5N	2100i, Edge Service, GOLD Maintenance Contract, 5 Day Turnaround, <b>5 Year</b> , New Contract
SVC2105i-SG5N	2105i, Edge Service, GOLD Maintenance Contract, 5 Day Turnaround, <b>5 Year</b> , New Contract

#### Add-On Accessory Replacement Service

Provides replacement chargers, docks, charging cables, or scan handles should they be damaged or stop working.

<b>ADD</b> SVCACC-SCN5	AddOn, Edge Service, Accessory Service , Scanner, <b>5 Year</b> . Service covers power supplies, chargers and cables.
------------------------	---

#### Add-On Battery Replacement Service

Provides replacement batteries as needed after a minimum of 18 months post-purchase.

<b>ADD</b> SVCBATTERY-SCN5	AddOn, Edge Service, Battery Service, Scanner, <b>5 Year</b> , 2 Replacement Batteries over life of the contract.
----------------------------	---

#### Add-On Device Replacement Service

Replacement devices should a device be damaged beyond repair.

<b>ADD</b> SVCREPLACE-SCN5	AddOn, Edge Service, Device Replacement, Scanner, <b>5 Year</b>
----------------------------	---

#### Add-On Spare Management Service

Manages every aspect of your spare pool.

<b>ADD</b> SVCSPAREMGMT-SCN5	AddOn, Edge Service, Advanced Exchange, Scanner, <b>5 Year</b> . Customer owned spare pool, Minimum Purchase required, contact your local Honeywell Service Representative for more information.
------------------------------	--

#### Add-On 2-Day Turnaround Depot Upgrade

Upgrade your Gold Maintenance Contract from 5-Day to 2-Day turnaround at the repair depot.

<b>ADD</b> SVC2DAYDEPOT-SCN5	AddOn, Edge Service, 2-Day Depot Upgrade, <b>5-Year</b> Agreement, Requires purchase of a <b>5 Year</b> Gold Maintenance Contract.
------------------------------	--

### Platinum Repair Services - 5 Year

The Edge Services Platinum Support contract offers 2-Day Depot Repairs or Spare Pool Management with 5 year contract that includes:

#### Service Overview

- Repair or replacement of damaged components
- SVCREPLACE-SCN5 - Replacement devices should a device be damaged beyond repair
- SVCACC-SCN5 - Accessory replacement service
- SVCBATTERY-SCN5 - Battery replacement service
- SVCSPAREMGMT-SCN5 - Spare pool management (optional, minimum quantity required)
- Telephone-based technical support

PART NUMBER	DESCRIPTION
SVC2100i-SP5N	2100i, Edge Service, PLATINUM Maintenance Contract, 1 Day Turnaround, <b>5 Year</b> , New Contract
SVC2105i-SP5N	2105i, Edge Service, PLATINUM Maintenance Contract, 1 Day Turnaround, <b>5 Year</b> , New Contract



# HONEYWELL REPAIR SERVICES

## 2100i/ 2105i - Repair Services Coverage

Service options tailored to customer requirements

2100i



2105i



Warranty Cover Against Product Defect

**BASIC Service**

Gold Coverage:

- Accidental Damage
- Wear & Tear

Flexible GOLD Add-Ons ordered separately

- SVCACC-SCN5 Accessories
- SVCBATTERY-SCN5 Batteries
- SVCREPLACE-SCN5 Device Replacement
- SVCSPAREMGMT-SCN5 Advanced Exchange

**GOLD Service**

Platinum Coverage

- Battery Replacement
- Coverage for Docks/ Chargers



Cables



Battery  
(3 Year – 1 replacement battery per 2105i)  
(5 Year – 2 replacement batteries per 2105i)



Charge Bases



Dock Power Supplies

- Accidental Damage
- Device Replacement
- Wear & Tear



**PLATINUM Service**

MODEL	COVERAGE	PART NUMBER	DESCRIPTION
2105i	BASIC	SVC2105i-EXW5	2105i & Base, BASIC, 10-15 Day Turnaround, 5 Years (3 Year Factory Warranty + 2 Year extended) (10 unit minimum)
2100i	GOLD	SVC2100i-SG5N	2100i, Edge Service, GOLD Maintenance Contract, 5 Day Turnaround, 5 Year, New Contract
2105i	GOLD	SVC2105i-SG5N	2105i, Edge Service, GOLD Maintenance Contract, 5 Day Turnaround, 5 Year, New Contract
	ADD	SVCACC-SCN5	AddOn, Edge Service, Accessory Service , Scanner, 5 Year. Service covers power supplies, chargers and cables.
	ADD	SVCBATTERY-SCN5	AddOn, Edge Service, Battery Service, Scanner, 5 Year, 2 Replacement Battery over life of contract
	ADD	SVCREPLACE-SCN5	AddOn, Edge Service, Device Replacement, Scanner, 5 Year
	ADD	SVCSPAREMGMT-SCN5	AddOn, Edge Service, Advanced Exchange, Scanner, 5 Year. Customer owned spare pool, Minimum Purchase required.
2100i	PLATINUM	SVC2100i-SP5N	2100i, Edge Service, PLATINUM Maintenance Contract, 1 Day Turnaround, 5 Year, New Contract
2105i	PLATINUM	SVC2105i-SP5N	2105i, Edge Service, PLATINUM Maintenance Contract, 1 Day Turnaround, 5 Year, New Contract

# MISCELLANEOUS

## Granit Ultra Cable Options - USB

### Cable Types

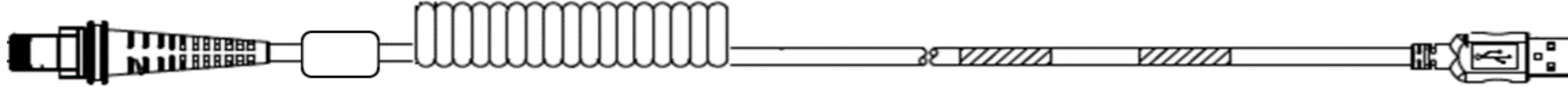
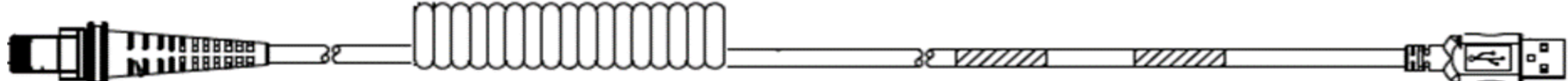
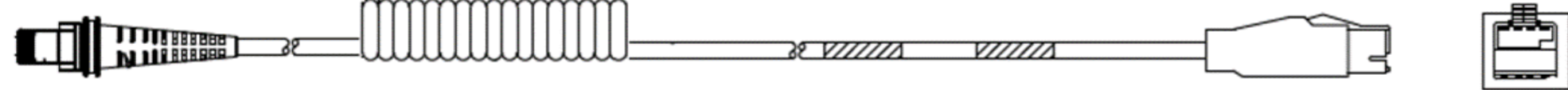
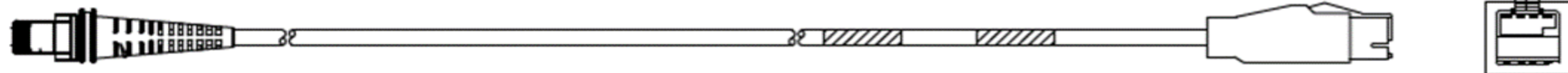
USB	PART NUMBER	DESCRIPTION	LENGTH	TYPE	NOTES
	CBL-500-300-S00-01	Cable: USB, black, Type A, 3m (9.8'), straight, 5v host power, industrial grade, w/o ferrite	3m	STRAIGHT	
					
	CBL-500-500-S00	Cable: USB, black, Type A, 5m (16.4'), straight, 5V host power	5m	STRAIGHT	
					
	CBL-500-300-C00	Cable: USB, black, Type A, 3m (9.8'), coiled, 5V host power	3m	COILED	
					
	CBL-500-300-C00-07	Cable: USB, black, Type A, 3m (9.8'), coiled, 5V host power, Industrial	3m	COILED	Industrial USB cable for freezer environments
					
	CBL-500-500-C00	Cable: USB, black, Type A, 5m (16.4'), coiled, 5V host power	5m	COILED	
					
	CBL-503-300-C00	Cable: USB, black, 12V locking, 3m (9.8'), coiled, 5V host power	3m	COILED	
					
	CBL-503-300-S00	Cable: USB, black, 12V locking, 3m (9.8'), straight, 5V host power	3m	STRAIGHT	
					

# MISCELLANEOUS

## Granit Ultra Cable Options - USB

### Cable Types

USB	PART NUMBER	DESCRIPTION	LENGTH	TYPE	NOTES
	CBL-503-500-C00	Cable: USB, black, 12V locking, 5m (16.4'), coiled, 5V host power	5m	COILED	
	CBL-500-200-C00	CABLE, USB TYPE A HSM 5V, COILED 2M (6.6')	2m	COILED	
	CBL-800-300-C00	Cable: USB, Type C, 3M, Coiled, 5V host power	3m	COILED	USB Type C Connector
	CBL-500-300-C00-02	Cable: USB, black, Type A, 3m (9.8'), coiled, 5V host power, right angle	3m	COILED	Right Angle Connector
	CBL-532-300-S00	CABLE, USBRETAIL, 12VKEY, 12VPWR, CCBAUXPWR	3m	STRAIGHT	12V Powered USB provides 5V to 1902 CCB and USB Comms

# MISCELLANEOUS

## Granit Ultra Cable Options - Serial

### Cable Types

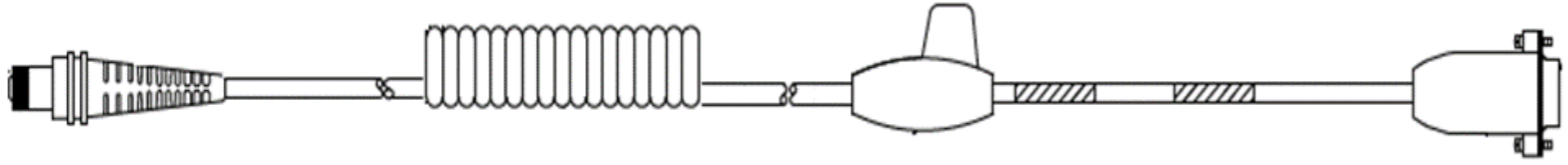
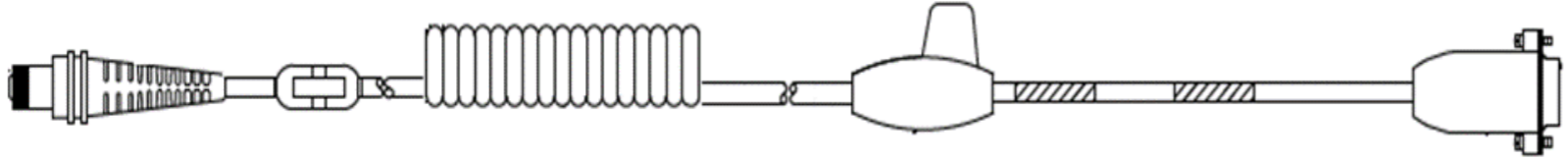
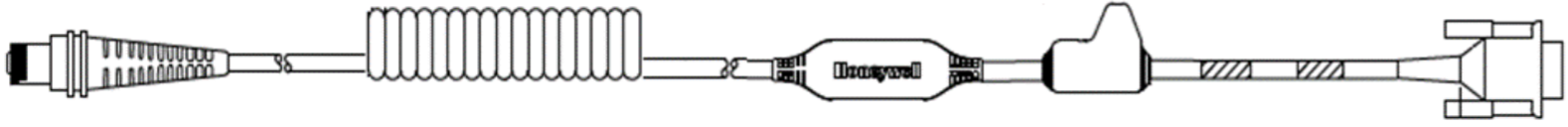
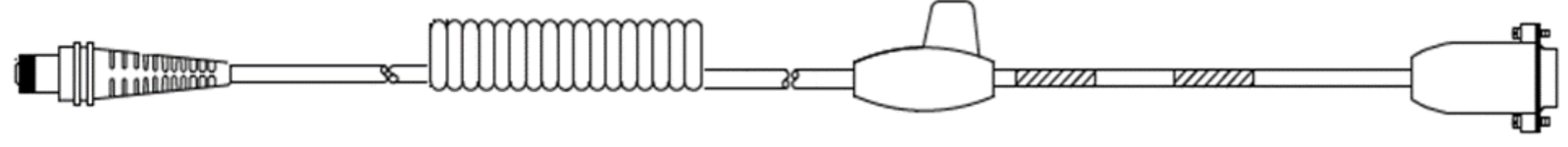
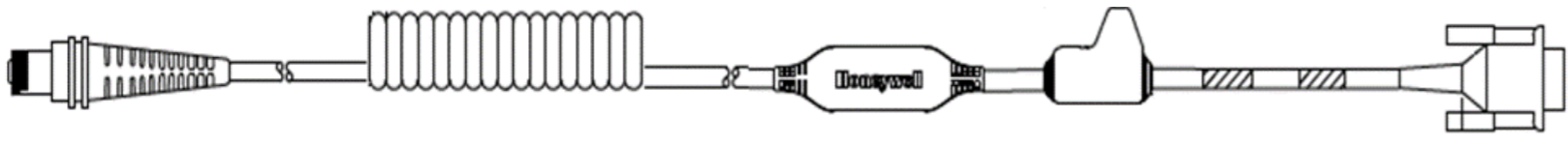
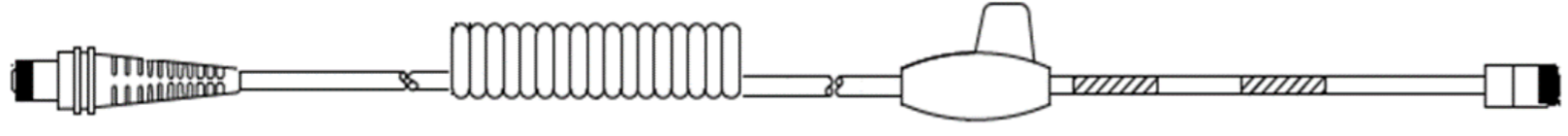
SERIAL	PART NUMBER	DESCRIPTION	LENGTH	TYPE	NOTES
	<b>CBL-020-300-C00-01</b>	Cable - Industrial: RS232 (5V signals), black, DB9 Female, 3m (9.8'), coiled, 5V external power with option for host power on pin 9, without ferrite	3m	COILED	Industrial Serial cable for freezer environments
					
	<b>CBL-020-300-C00-02</b>	Cable - Industrial: RS232 (5V signals), black, DB9 Female, 3m (9.8'), coiled, 5V external power with option for host power on pin 9, with ferrite	3m	COILED	Industrial Serial cable for freezer environments
					
	<b>CBL-120-300-C00</b>	Cable: RS232C (+/-12V signals), black, DB9 Female, 3m (9.8'), coiled, 5V external power with option for host power on pin 9	3m	COILED	
					
	<b>CBL-220-300-C00</b>	Cable: RS232 (+5V signals), black, DB9 Male, 3m (9.8'), coiled, external power with option for host power on pin 9 for connection to Wincor Beetle	3m	COILED	
					
	<b>CBL-320-300-C00</b>	Cable: RS232 (+/-12V signals), black, DB9 Male, 3m (9.8'), coiled, external power with option for host power on pin 9	3m	COILED	
					
	<b>CBL-420-300-C00</b>	Cable: RS232 (5V signals), Honeywell Bioptic Stratos Aux, black, 10 pin modular, 3m (9.8'), coiled, host power possible (dependent upon scanner and Stratos models)	3m	COILED	
					

# MISCELLANEOUS

## Granit Ultra Cable Options - Serial / Keyboard Wedge

### Cable Types

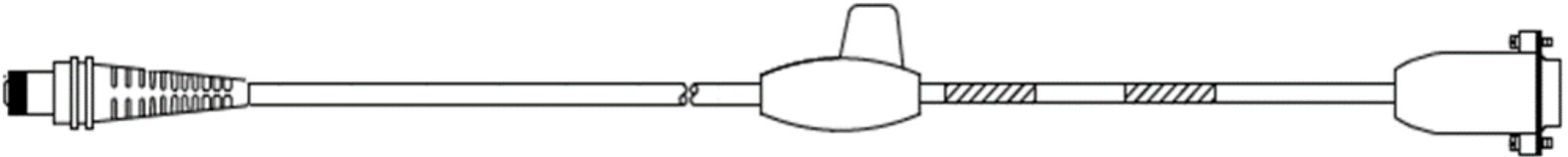
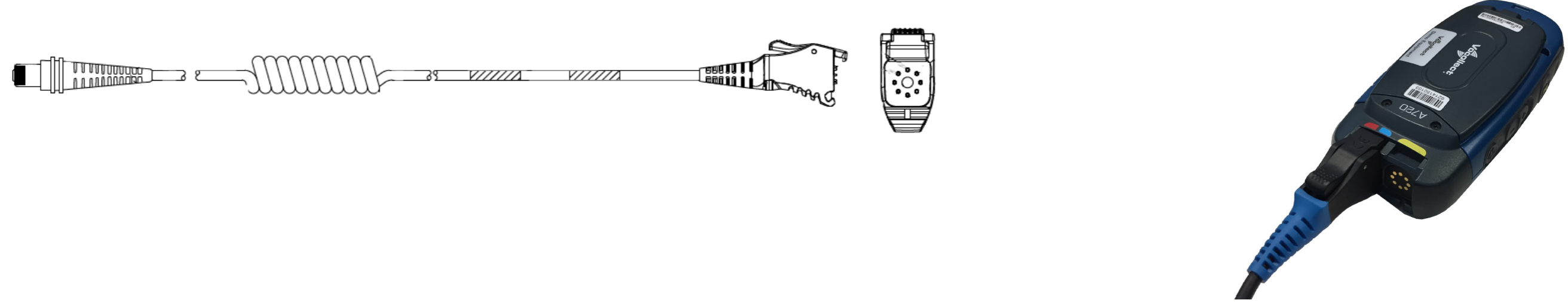
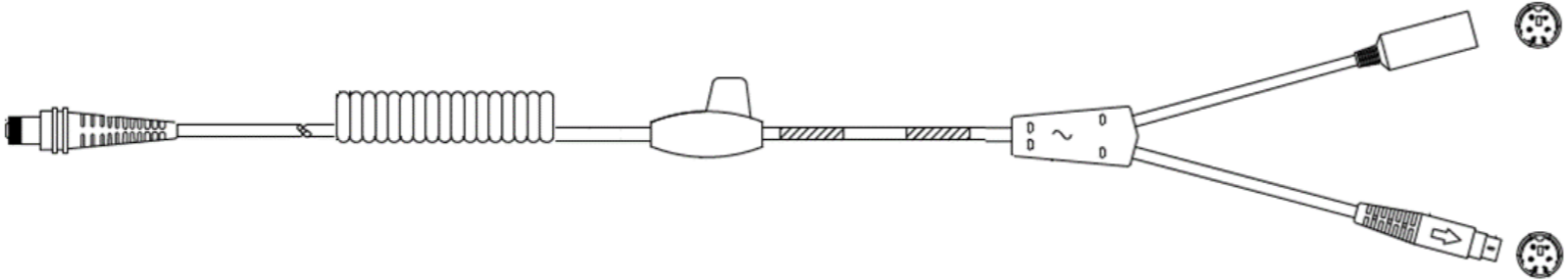
SERIAL	PART NUMBER	DESCRIPTION	LENGTH	TYPE	NOTES
	CBL-431-300-S00	Cable: RS232 (+/-12V signals), Verifone Ruby, Sapphire and Topaz Terminals, black, 8 pin modular; straight, host power on pin 8		STRAIGHT	
					
	CBL-GIL-300-S00-02	Cable: RS232 (5V signals), Gilbarco terminal, black, DB9 Female, 3m (9.8'), straight	3m	STRAIGHT	
					
	CBL-801-370-C00	Cable, RS232, Granit to Vocollect Talkman, Host 5V power only, 3.7m, Coiled, w/o ferrite.	3.7m	COILED	Connects to Vocollect A720 or A720X via Serial
					
KEYBOARD WEDGE	PART NUMBER	DESCRIPTION	LENGTH	TYPE	NOTES
	CBL-720-300-C00	Cable: KBW, black, PS2, 3m (9.8'), coiled, 5 V external power with option for host power	3m	COILED	
					

# MISCELLANEOUS

## Optional Parts



PART NUMBER	DESCRIPTION
CCB23-100BT-07N	Base: Charge and Communication. Class 1 Bluetooth. 100m (300'), up to 3 scanners can be connected. Compatible with RS232/USB/KBW cables (sold separately).



PART NUMBER	DESCRIPTION
PS-05-3000-W-U	Power Supply: Includes US, UK, ANZ,EU plugs, 3.0A @ 5.2VDC, 100-255VAC @ 50-60Hz



PART NUMBER	DESCRIPTION
BAT-SCN11	Smart battery: Lithium-ion battery for Xenon™ Ultra 1962 Bluetooth® scanners



PART NUMBER	DESCRIPTION
AP-100BT-07N	Bluetooth Access point for Granit Ultra, XP and Granit 1981i scanners. Class 1 Bluetooth, 100m, up to 7 Granit scanners can be connected (cables sold separately).



PART NUMBER	DESCRIPTION
199XIORING	O-ring for IP sealing with Granit Ultra and Granit XP scanner cables. Pack of 10.



PART NUMBER	DESCRIPTION
PSORING	O-ring for IP65 sealing with Granit Ultra power adapter (5V 3A) cables. Pack of 10.



PART NUMBER	DESCRIPTION
199XILNYRDPLT	Replacement metal lanyard plate for connection to tool balancer. Compatible with Granit Ultra 210Xi and XP 199Xi models. Pack of 1.



PART NUMBER	DESCRIPTION
CCB23ORING	Cordless IP65 O-Ring O-ring for IP65 sealing with Granit Ultra base cables. Pack of 10.

# MISCELLANEOUS

## Optional Parts



**PART NUMBER**      **DESCRIPTION**

VMHOLDER2K      Vehicle Mount Cup: Contains vehicle mount Granit scanner cup with 1 inch ('B' Size) diameter ball joint attachment. Recommended for use with VMHOLDER3K (mounting arm with round attachment plate) or VMHOLDER4K (mounting arm with vehicle clamp), not included.



**PART NUMBER**      **DESCRIPTION**

VMHOLDER3K      Vehicle mount kit: Contains adjustable arm with 1 inch ('B' Size) diameter ball joints and circular mounting plate. Recommended for use with VMHOLDER2K cup (not included).



**PART NUMBER**      **DESCRIPTION**

VMHOLDER4K      Vehicle mount kit: Contains adjustable arm with 1 inch ('B' Size) diameter ball joints and square post clamp base for posts up to 3 in. wide. Recommended for use with VMHOLDER2K cup (not included).



VMHOLDER2K and VMHOLDER3K  
Front and Rear views



VMHOLDER2K and VMHOLDER4K  
Front and Rear views



# MISCELLANEOUS

## Optional Parts



PART NUMBER	DESCRIPTION
2105IENDCAP	Cordless Granit Ultra end cap (battery door) for 2105i models. One per pack.



PART NUMBER	DESCRIPTION
STND-33F00-012-4	Stand: gray, 33cm (13") height, flexible rod, weighted base, Granit cup



PART NUMBER	DESCRIPTION
HOLDER-010-U	Holder Kit: Plastic bracket facilitates mounting of scanner to wall; two mounting screws included in kit.



PART NUMBER	DESCRIPTION
TOOLBAL	Tool Balancer Suspension reel commonly used for scanner mounting/retention on vehicles and in fixed locations.



PART NUMBER	DESCRIPTION
HOLSTER-INDUSTRIAL	Holster Securely holds Granit and Granit XP scanners, leaving hands free to accomplish tasks



PART NUMBER	DESCRIPTION
520-24-H3	Scanner heater to prevent fogging in freezer operations. Includes cable retractor. For use with <b>24V</b> power. Configured for Granit (XP and legacy) scanner compatibility.
520-36/48-H3	Scanner heater to prevent fogging in freezer operations. Includes cable retractor. For use with <b>36-48V</b> power. Configured for Granit (XP and legacy) scanner compatibility.

# MISCELLANEOUS

## Optional Parts



Power Supply for Granit Charge Base  
CCB23-100BT-07N



Power Supply for Serial Cable  
CBL-020-300-C00-01



50122315-001  
US Plug



50122316-001  
UK Plug



50122317-001  
ANZ Plug



50122318-001  
EU Plug

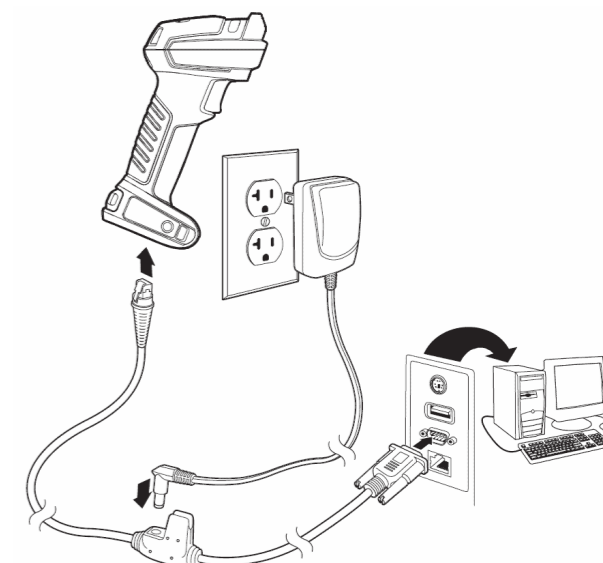























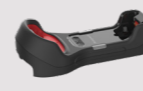





















PART NUMBER	DESCRIPTION
PS-05-3000-W-U	Power Supply: Includes US, UK, ANZ,EU plugs, 3.0A @ 5.2VDC, 100-255VAC @ 50-60Hz  To be used with CCB23-100BT-07N or COB23

PART NUMBER	DESCRIPTION
46-00525	NA Power Supply: 1.0A @ 5.2VDC, 90-255VAC @ 50-60Hz
46-00526	EU Power Supply: 1.0A @ 5.2VDC, 90-255VAC @ 50-60Hz
46-00528	ANZ Power Supply: 1.0A @ 5.2VDC, 90-255VAC @ 50-60Hz

# APPENDIX

## Compare Granit XP 1990i/ 1991i to Granit Ultra 2100i/ 2105i

ACCESSORIES											
Category	Description	 Granit 1980i	 Granit XP 1990i	 Granit Ultra 2100i	 Granit 1981i	 Granit XP 1991i	 Granit Ultra 2105i	Is the Granit XP part the same as Granit Ultra?	Is the Granit XP part compatible with Granit Ultra?	Customer Installable	Notes
Batteries	Standard Battery	-	-	-	 BAT-SCN01 BAT-SCN01A	-	-	No	No	Yes	BAT-SCN01 and BAT-SCN01A is compatible with the 1991i, but the 1991i battery status icon and smart battery information will only function when the BAT-SCN05 Smart Battery is installed in the 1991i.
	Smart Battery	-	-	-	-	 BAT-SCN05	 BAT-SCN11	No	No	Yes	BAT-SCN11 is not compatible with the 1981i or 1991i. BAT-SCN05 is compatible with the 1981i, but it will not provide Smart Battery information whilst installed in the 1981i.
Chargers	4-Bay Desktop Battery Charger	-	-	-	 MB4-BAT-SCN01NADO	 MB4-BAT-SCN01NADO	New Battery Charger Coming Soon	No	No	Yes	
	4-Bay Wall Battery Charger	-	-	-	 MB4-BAT-SCN01NAWO	 MB4-BAT-SCN01NAWO	New Battery Charger Coming Soon	No	No	Yes	
Charge Bases	Charge and Communications Base (CCB)	-	-	-	 CCB02-100BT-07N	 CCB22-100BT-03N	 CCB23-100BT-07N	No	No	Yes	CCB23 is not compatible with Granit 1981i or Granit XP 1991i CCB02 is compatible with Granit XP 1991i. CCB22 is compatible with Granit 1981i. CCB02 firmware must be upgraded before it can be used to upgrade firmware on a Granit XP 1991i.
	Charge Only Base (COB)	-	-	-	 COB02	 COB22		No	No	Yes	
	Power Supply	-	-	-	 PS-05-1000W-I	 PS-05-1000W-I	 PS-05-1000W-U	No	No	Yes	
Desktop Mounts	Rigid Stand	 STND-30R00-011-4	 STND-30R00-011-4	 STND-30R00-011-4	 STND-30R00-011-4	 STND-30R00-011-4	 STND-30R00-011-4	Yes	Yes	Yes	
	Flexible Stand	 STND-33F00-012-4	 STND-33F00-012-4	 STND-33F00-012-4	 STND-33F00-012-4	 STND-33F00-012-4	 STND-33F00-012-4	Yes	Yes	Yes	
Suspension	Tool Balancer	 TOOLBAL	 TOOLBAL	 TOOLBAL	 TOOLBAL	 TOOLBAL	 TOOLBAL	Yes	Yes	Yes	
Mounting	Vehicle Mount	 VMHOLDER2K	 VMHOLDER2K	 VMHOLDER2K	 VMHOLDER2K	 VMHOLDER2K	 VMHOLDER2K	No	Yes	Yes	VMHOLDERK and VMHOLDER2K are compatible with both Granit, Granit XP and Granit Ultra scanners.

# MISCELLANEOUS

## Disclaimer

---

Honeywell International Inc. (“HII”) reserves the right to make changes in specification and other information contained in this document without prior notice, and the reader should in all cases consult HII to determine whether any such changes have been made. The information in this publication does not represent a commitment on the part of HII.

HII shall not be liable for technical or editorial errors or omissions contained herein; nor for incidental or consequential damages resulting the furnishing, performance, or use of this material.

This document contains proprietary information that is protected by copyright. All rights are reserved. No part of this document may be photocopied, reproduced, or translated into another language with-out prior written consent of HII.

Web Address: [automation.honeywell.com](http://automation.honeywell.com)

The Bluetooth trademarks are owned by Bluetooth SIG, Inc., U.S.A and licensed to Honeywell.

Other product names mentioned in the manual may be trademarks of registered trademarks of their respective companies and are the property of their respective owners.

All rights reserved.

### For more information

[automation.honeywell.com](http://automation.honeywell.com)

### Honeywell Industrial Automation

855 S Mint St  
Charlotte, NC 28202  
800-582-4263  
[www.honeywell.com](http://www.honeywell.com)